

## SOT-23 Plastic-Encapsulate Diodes

### BAT54/A/C/S SCHOTTKY BARRIER DIODE

#### SOT-23

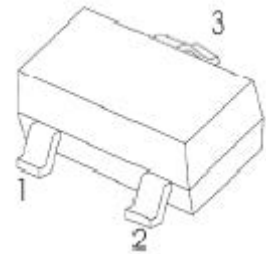

#### FEATURES

- Extremely Fast Switching Speed

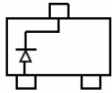

BAT54 MARKING: KL1

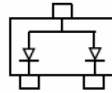

BAT54A MARKING: KL2

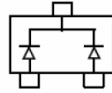



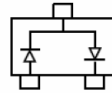

BAT54C MARKING: KL3



BAT54S MARKING: KL4

#### MARKING:

| BAT54   | BAT54A  | BAT54C  | BAT54S   |
|---|---|---|--|
|  |  |  |  |

Solid dot = Green molding compound device.

#### MAXIMUM RATINGS ( $T_a=25^\circ\text{C}$ unless otherwise noted )

| Parameter   | Symbol          | Value      | Unit                      |
|---|-----------------|------------|---------------------------|
| Peak Repetitive Reverse Voltage                                       | $V_{RRM}$       | 30         | V                         |
| Working Peak Reverse Voltage  | $V_{RWM}$       |            |                           |
| DC Blocking Voltage   | $V_R$           |            |                           |
| Forward Continuous Current  | $I_{FM}$        | 200        | mA                        |
| Non-repetitive Peak Forward Surge Current @ $t=8.3\text{ms}$          | $I_{FSM}$       | 600        | mA                        |
| Repetitive Peak Forward Current @ $t \leq 1\text{s}, \delta \leq 0.5$ | $I_{FRM}$       | 300        | mA                        |
| Power Dissipation   | $P_D$           | 200        | mW                        |
| Thermal Resistance from Junction to Ambient                           | $R_{\theta JA}$ | 500        | $^\circ\text{C}/\text{W}$ |
| Operating Junction Temperature Range                                  | $T_j$           | -40 ~ +125 | $^\circ\text{C}$          |
| Storage Temperature Range   | $T_{stg}$       | -55 ~ +150 | $^\circ\text{C}$          |

#### ELECTRICAL CHARACTERISTICS( $T_a=25^\circ\text{C}$ unless otherwise specified)

| Parameter             | Symbol     | Min | Typ | Max  | Unit          | Test conditions   |
|-----------------------|------------|-----|-----|------|---------------|---|
| Reverse voltage       | $V_{(BR)}$ | 30  |     |      | V             | $I_R=100\mu\text{A}$  |
| Forward voltage       | $V_F$      |     |     | 0.24 | V             | $I_{F1}=0.1\text{mA}$   |
|                       |            |     |     | 0.32 | V             | $I_{F2}=1\text{mA}$   |
|                       |            |     |     | 0.40 | V             | $I_{F3}=10\text{mA}$  |
|                       |            |     |     | 0.50 | V             | $I_{F4}=30\text{mA}$  |
|                       |            |     |     | 1    | V             | $I_{F5}=100\text{mA}$   |
| Reverse current       | $I_R$      |     |     | 2    | $\mu\text{A}$ | $V_R=25\text{V}$  |
| Diode capacitance     | $C_D$      |     |     | 10   | pF            | $V_R=1\text{V}, f=1\text{MHz}$                                  |
| Reverse recovery time | $t_{rr}$   |     |     | 5    | ns            | $I_F=I_R=10\text{mA}$<br>$I_{rr}=0.1 \times I_R, R_L=100\Omega$ |

# Typical Characteristics

### Forward Characteristics

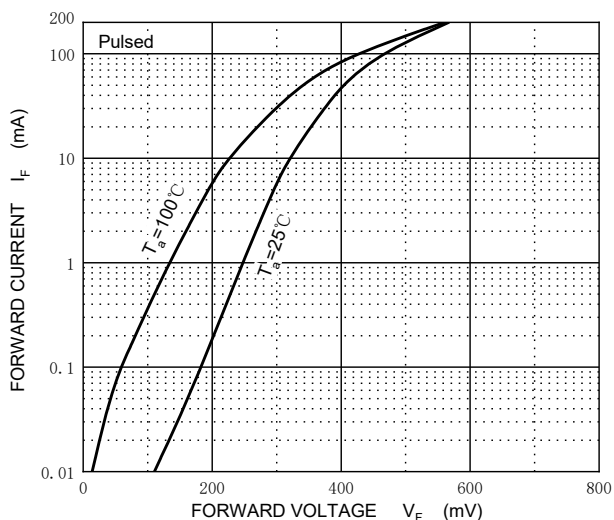

### Reverse Characteristics

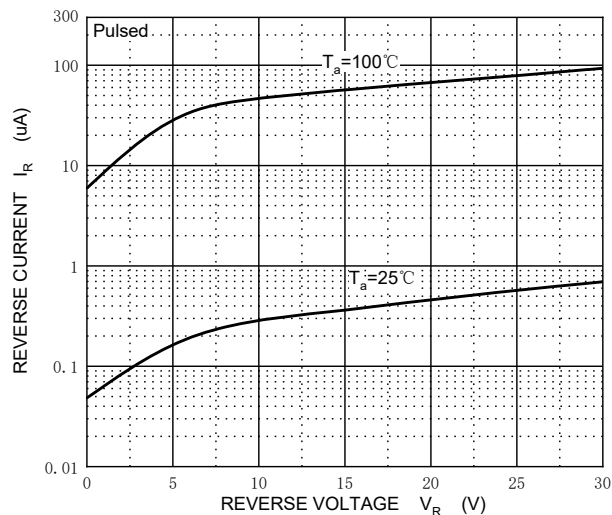

### Capacitance Characteristics

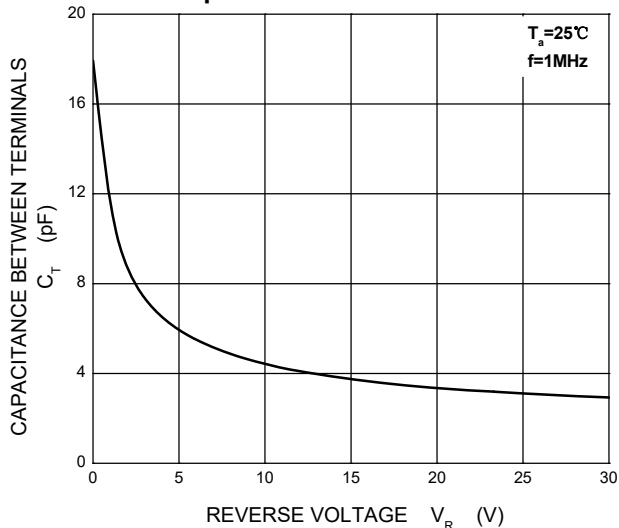

### Power Derating Curve

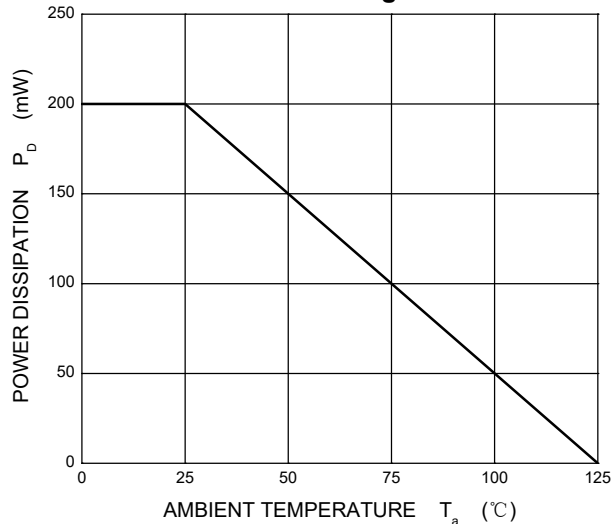

## SOT-23 Package Outline Dimensions

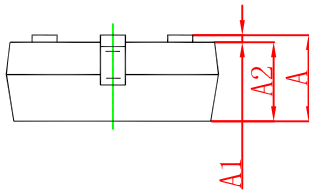
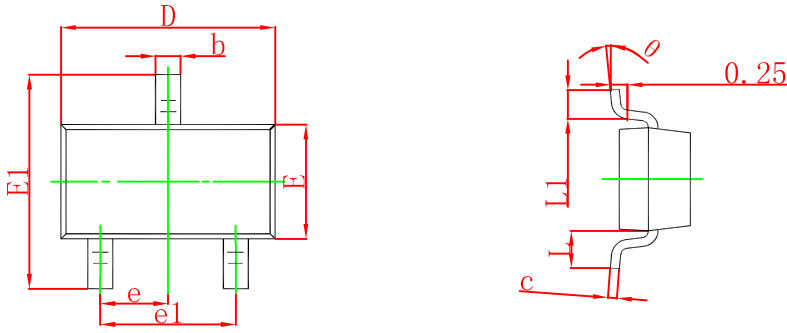

| Symbol | Dimensions In Millimeters |       | Dimensions In Inches |       |
|--------|---------------------------|-------|----------------------|-------|
|        | Min                       | Max   | Min                  | Max   |
| A      | 0.900                     | 1.150 | 0.035                | 0.045 |
| A1     | 0.000                     | 0.100 | 0.000                | 0.004 |
| A2     | 0.900                     | 1.050 | 0.035                | 0.041 |
| b      | 0.300                     | 0.500 | 0.012                | 0.020 |
| c      | 0.080                     | 0.150 | 0.003                | 0.006 |
| D      | 2.800                     | 3.000 | 0.110                | 0.118 |
| E      | 1.200                     | 1.400 | 0.047                | 0.055 |
| E1     | 2.250                     | 2.550 | 0.089                | 0.100 |
| e      | 0.950 TYP                 |       | 0.037 TYP            |       |
| e1     | 1.800                     | 2.000 | 0.071                | 0.079 |
| L      | 0.550 REF                 |       | 0.022 REF            |       |
| L1     | 0.300                     | 0.500 | 0.012                | 0.020 |
| θ      | 0°                        | 8°    | 0°                   | 8°    |

## SOT-23 Suggested Pad Layout

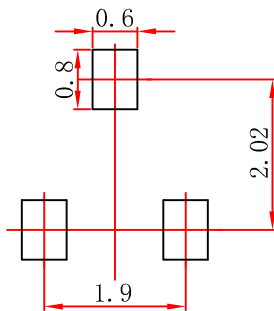

**Note:**

1. Controlling dimension: in millimeters.
2. General tolerance:  $\pm 0.05\text{mm}$ .
3. The pad layout is for reference purposes only.

**NOTICE**

JSCJ reserves the right to make modifications, enhancements, improvements, corrections or other changes without further notice to any product herein. JSCJ does not assume any liability arising out of the application or use of any product described herein.

# SOT-23 Tape and Reel

## SOT-23 Embossed Carrier Tape

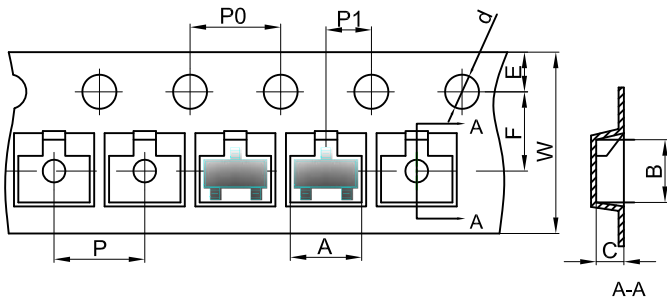

### Packaging Description:

SOT-23 parts are shipped in tape. The carrier tape is made from a dissipative (carbon filled) polycarbonate resin. The cover tape is a multilayer film (Heat Activated Adhesive in nature) primarily composed of polyester film, adhesive layer, sealant, and anti-static sprayed agent. These reeled parts in standard option are shipped with 3,000 units per 7" or 17.8cm diameter reel. The reels are clear in color and is made of polystyrene plastic (anti-static coated).

Dimensions are in millimeter

| Pkg type | A    | B    | C    | d     | E    | F    | P0   | P    | P1   | W    |
|----------|------|------|------|-------|------|------|------|------|------|------|
| SOT-23   | 3.15 | 2.77 | 1.22 | Ø1.50 | 1.75 | 3.50 | 4.00 | 4.00 | 2.00 | 8.00 |

## SOT-23 Tape Leader and Trailer

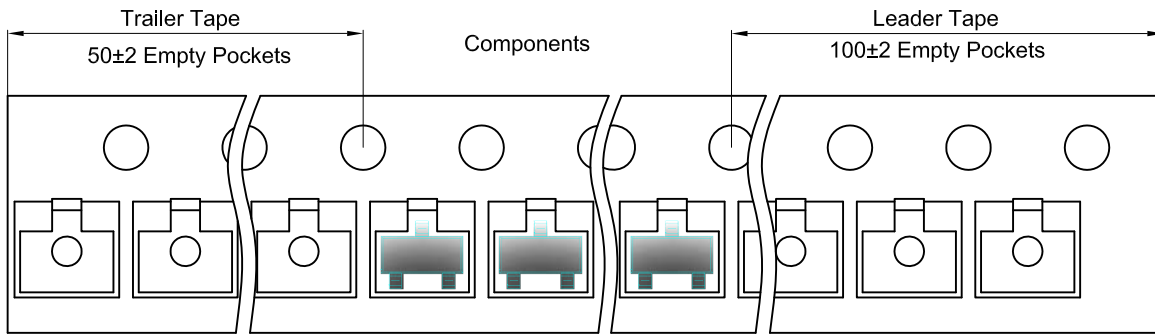

## SOT-23 Reel

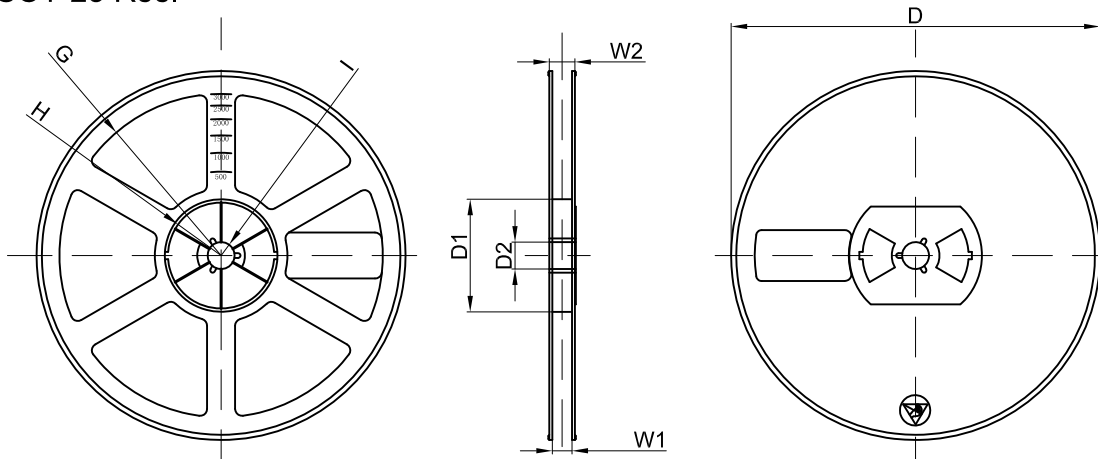

Dimensions are in millimeter

| Reel Option | D       | D1    | D2    | G      | H      | I     | W1   | W2    |
|-------------|---------|-------|-------|--------|--------|-------|------|-------|
| 7"Dia       | Ø178.00 | 54.40 | 13.00 | R78.00 | R25.60 | R6.50 | 9.50 | 12.30 |

| REEL     | Reel Size | Box        | Box Size(mm) | Carton      | Carton Size(mm) | G.W.(kg) |
|----------|-----------|------------|--------------|-------------|-----------------|----------|
| 3000 pcs | 7 inch    | 45,000 pcs | 203×203×195  | 180,000 pcs | 438×438×220     |          |